

1

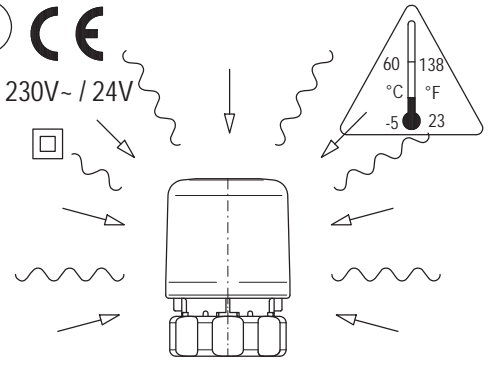

2

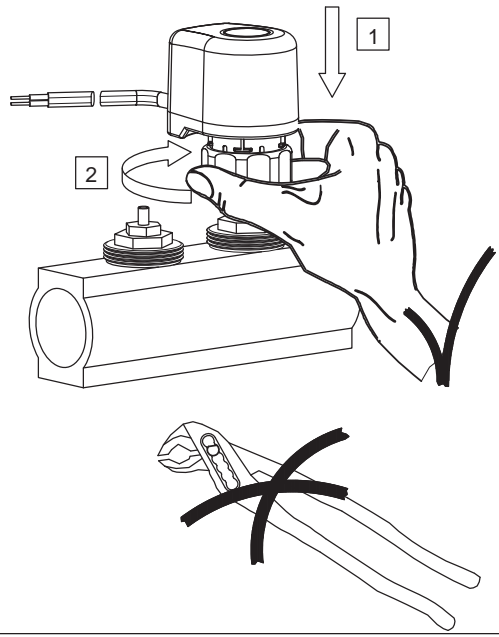

3

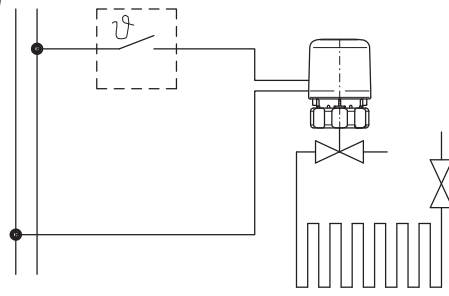

4

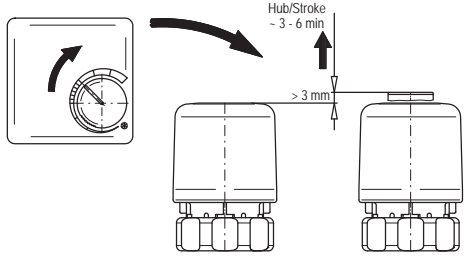

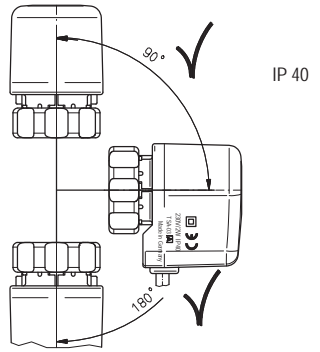

6

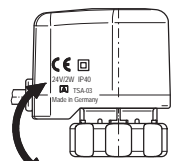
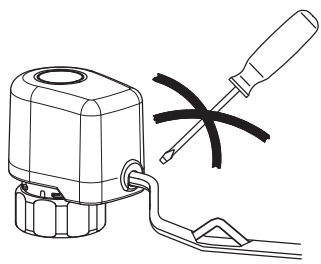

5



U = 24 V ±10%
 P ~ 2 W
 I_{max} ~ 184 mA
 I_N ~ 84 mA
 CE IP 40 
 -5°C ... 60°C
 F ~ 90 N
 Typ: TSA 03 

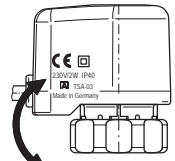

U = 230 V ~ ±10%
 P ~ 2 W
 I_{max} ~ 140 mA
 I_N ~ 9 mA
 CE IP 40 
 -5°C ... 60°C
 F ~ 90 N
 Typ: TSA 03 